

Operating Instructions

OVEN

GB

English, 1

IF 89 K GP.A UK
IF 89 K GP.A IX UK

Contents

GB

Installation, 2-3

Positioning
Electrical connection

Description of the appliance, 4

Overall view
Control panel
Display

Start-up and use, 5

Setting the clock
Setting the timer
Starting the oven

Cooking modes, 6-8

Cooking modes
Technical data
Programming cooking
Practical cooking advice
Cooking advice table

Precautions and tips, 9

General safety
Disposal
Respecting and conserving the environment

Care and maintenance, 10-11

Switching the appliance off
Cleaning the appliance
Cleaning the oven door
Replacing the light bulb
AUTOMATIC CLEANING mode

Assistance, 12

Installation

GB

! Before operating your new appliance please read this instruction booklet carefully. It contains important information concerning the safe operation, installation and maintenance of the appliance.

! Please keep these operating instructions for future reference. Pass them on to any new owners of the appliance.

Positioning

! Keep packaging material out of the reach of children.

It can become a choking or suffocation hazard. (see *Precautions and tips*).

! The appliance must be installed by a qualified professional in accordance with the instructions provided. Incorrect installation may cause harm to people and animals or may damage property.

Built-in appliance

Use a suitable cabinet to ensure that the appliance functions properly.

- The panels adjacent to the oven must be made of heat-resistant material.
- Cabinets with a veneer exterior must be assembled with glues which can withstand temperatures of up to 100°C.
- To install the oven under the counter (see *diagram*) or in a kitchen unit, the cabinet must have the following dimensions:

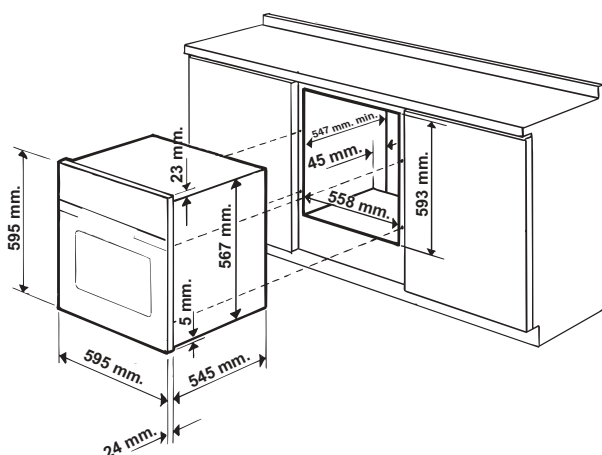

! The appliance must not come into contact with electrical parts once it has been installed. The indications for consumption given on the data plate have been calculated for this type of installation.

Ventilation

To ensure adequate ventilation is provided, the back panel of the cabinet must be removed. It is advisable to install the oven so that it rests on two strips of wood, or on a completely flat surface with an opening of at least 45 x 560 mm (see *diagrams*).

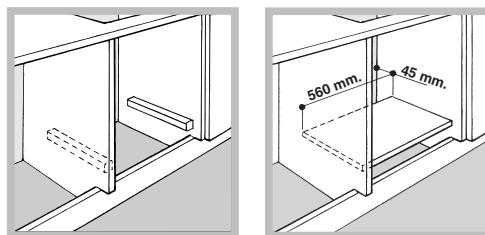

Centring and fixing

Position the 4 tabs on the side of the oven so that they are aligned with the 4 holes on the outer frame. Adjust the tabs in accordance with the thickness of the cabinet side panel, as shown below:

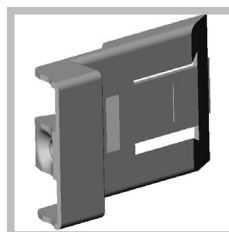

20 mm thick: take off the removable part of the tab (see *diagram*).

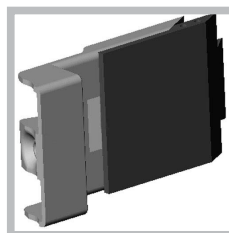

18 mm thick: use the first groove, which has already been set in the factory (see *diagram*).

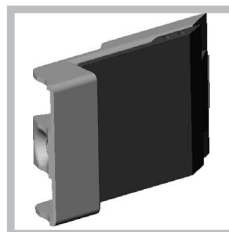

16 mm thick: use the second groove (see *diagram*).

Secure the appliance to the cabinet by opening the oven door and inserting 4 screws into the 4 holes on the outer frame.

! All parts which ensure the safe operation of the appliance must not be removable without the aid of a tool.

Electrical connection

! Ovens with a three-pole power supply cable are designed to operate with alternated current at the supply frequency and voltage indicated on the data plate (at the bottom of the oven dashboard). The earthing conductor of the cable is the yellow-green conductor.

Two types of connection are provided:

Connection n° 1

Connecting the power supply cable to the mains.

Fit a normalized plug to the cable, which corresponds to the load indicated on the data plate; if the cooker is connected directly to the mains, an omnipolar circuit-breaker with a minimum opening of 3 mm between the contacts, suitable for the load indicated and complying with current directives, must be installed between the appliance and the mains (the earthing wire must not be interrupted by the circuit-breaker). The power supply cable must be positioned so that it does not exceed room temperature by 50°C at any point of its length.

Before making the connection check that:

- the circuit breakers or fuses of the home system can support appliance load (see data plate);
- the power supply system has an efficient earthing connection which complies with the provisions of current regulations and the law;
- there is easy access to the socket or the omnipolar circuit-breaker once the cooker has been installed.

! do not use reducers, adapters or shunts as these could cause heating or burning.

Connection n° 2

Disposing of the plug.

! THIS APPLIANCE MUST BE EARTHED.

Ensure that before disposing of the plug itself, you make the pins unusable so that it cannot be accidentally inserted into a socket. Instructions for connecting cable to an alternative plug:

! the wires in the mains lead are coloured in accordance with the following code:

Green & Yellow	-Earth
Blue	-Neutral
Brown	-Live

If the colours of the wires in the mains lead do not correspond with the coloured markings identifying the terminals in your plug, proceed as follows.

Connect Green & Yellow wire to terminal marked "E" or 6 or coloured Green or Green & Yellow.

Connect Brown wire to terminal marked "L" or coloured Red. Connect Blue wire to terminal marked "N" or coloured Black. If a 13 amp plug (BS 1363) is used it must be fitted with a 13 amp fuse. A 15 amp plug must be protected by a 15 amp fuse, either in the plug or adaptor or at the distribution board. If you are in any doubt about the electrical supply to your machine, consult a qualified electrician before use.

How to connect an alternative plug

The wires in this mains lead are coloured in accordance with the following code:

BLUE "NEUTRAL" (N)
BROWN "LIVE" (L)
GREEN AND YELLOW
"EARTH" (E)

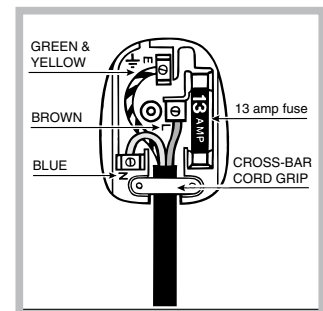

Disposing of the appliance

When disposing of the appliance please remove the plug by cutting the mains cable as close as possible to the plug body and dispose of it as described above.

! The plug and socket must be easily accessible.

! The cable must be checked regularly and replaced by authorised technicians only (see Assistance).

Description of the appliance

Overall view

GB

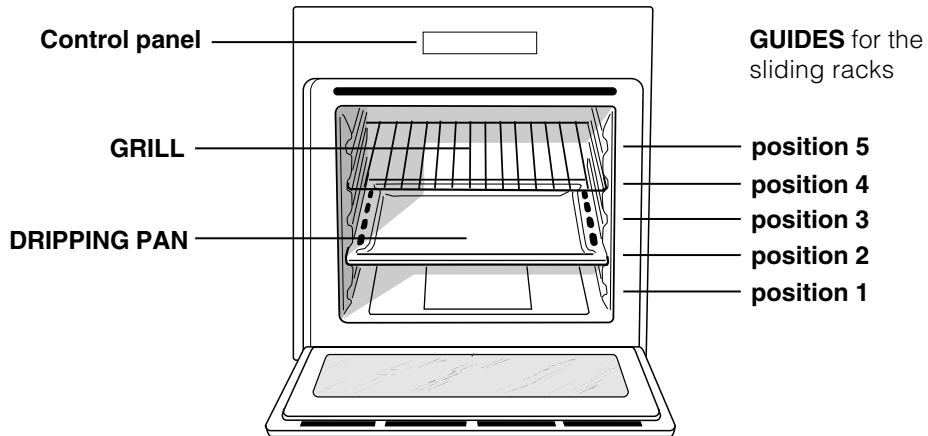

Control panel

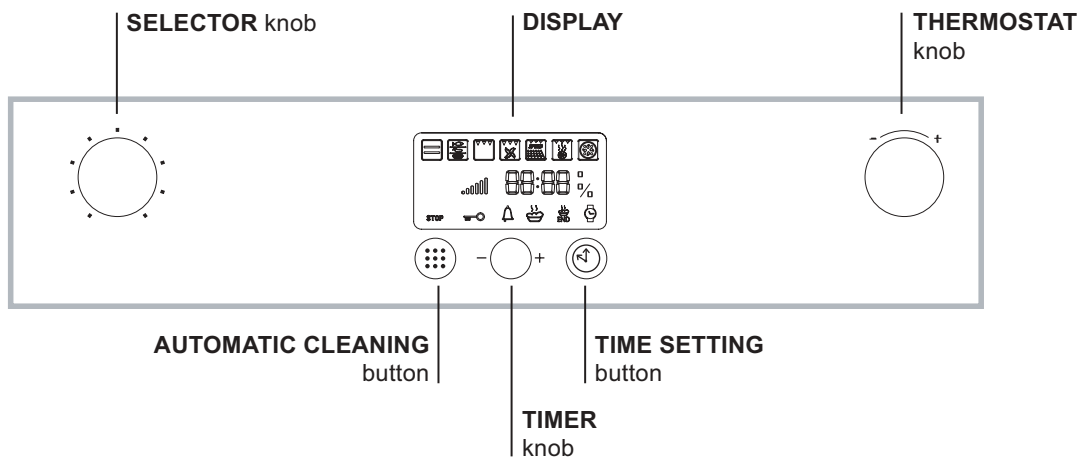



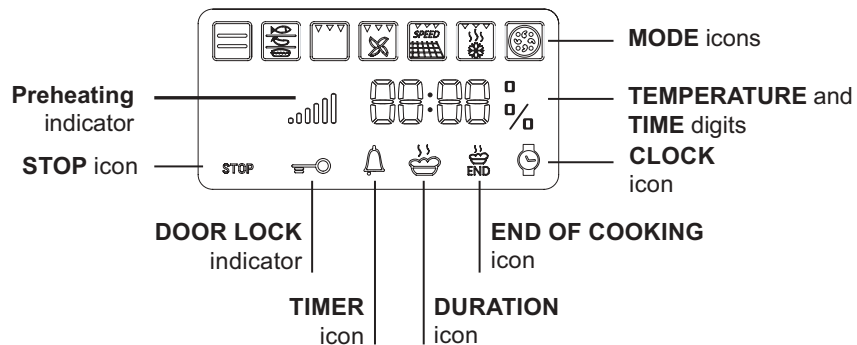

Display



! The first time you use your appliance, heat the empty oven with its door closed and at its maximum temperature for at least half an hour. Make sure that the room is well ventilated before switching the oven off and opening the oven door. The appliance may emit a slightly unpleasant odour caused by protective substances used during the manufacturing process burning away.



Setting the clock

! The clock may be set when the oven is switched off or when it is switched on, provided that the end time of a cooking cycle has not been programmed previously.

1. Press the  button several times until the  icon and the first two numerical digits on the display start to flash.
2. Turn the TIMER KNOB towards “+” and “-” to adjust the hour value.
3. Press the  button again so that the other two numerical digits on the DISPLAY begin to flash.
4. Turn the TIMER KNOB towards “+” and “-” to adjust the minute value.
5. Press the  button again to confirm.

Setting the timer

! This function does not interrupt cooking and does not affect the oven; it is simply used to activate the buzzer when the set amount of time has elapsed.

1. Press the  button several times until the  icon and the three digits on the display begin to flash.
2. Turn the TIMER KNOB towards “+” and “-” to adjust the minute value.
3. Press the  button again to confirm.
The display will then show the time as it counts down. When this period of time has elapsed the buzzer will be activated.

Starting the oven

1. Select the desired cooking mode by turning the SELECTOR knob.
2. The oven begins its preheating stage and the preheating indicator lights up.
The temperature may be changed by turning the THERMOSTAT knob.

3. When the preheating indicator  switches off and a buzzer sounds the preheating process is complete: you may now place the food in the oven.
4. During cooking it is always possible to:
 - Change the cooking mode by turning the SELECTOR knob.
 - Change the temperature by turning the THERMOSTAT knob.
 - Set the cooking duration and the cooking end time (see *Cooking modes*).
 - Stop cooking by turning the SELECTOR knob to the “0” position.
5. If a blackout occurs while the oven is already in operation, an automatic system within the appliance will reactivate the cooking mode from the point at which it was interrupted, provided that the temperature has not dropped below a certain level. Programmed cooking modes which have not started will not be restored and must be reprogrammed.

! There is no preheating stage for the GRILL mode.

! Never put objects directly on the bottom of the oven; this will prevent the enamel coating from being damaged.

! Always place cookware on the rack(s) provided.

Cooling ventilation

In order to cool down the external temperature of the oven, a cooling fan blows a stream of air between the control panel and the oven door. At the beginning of the AUTOMATIC CLEANING cycle, the cooling fan operates at low speed.

! Once cooking has been completed, the cooling fan continues to operate until the oven has cooled down sufficiently.

Oven light

When the oven is not in operation, the lamp can be switched on at any time by opening the oven door.

Cooking modes

GB

Cooking modes

! All cooking modes have a default cooking temperature which may be adjusted manually between 40°C and 250°C as desired. In the GRILL mode, the default power level value is indicated as a percentage (%) and may also be adjusted manually.



TRADITIONAL mode

When using this traditional cooking mode, it is best to use one cooking rack only. If more than one rack is used, the heat will be distributed unevenly.



MULTILEVEL mode

Since the heat remains constant throughout the oven, the air cooks and browns food in a uniform manner. A maximum of two racks may be used at the same time.



GRILL mode

By turning the THERMOSTAT knob, the different power levels which may be set will appear on the display; these range between 50% and 100%. The high and direct temperature of the grill is recommended for food which requires a high surface temperature. Always cook in this mode with the oven door partially open.



GRATIN mode

This combination of features increases the effectiveness of the unidirectional thermal radiation provided by the heating elements through the forced circulation of air throughout the oven. This helps prevent food from burning on the surface and allows the heat to penetrate right into the food. Always cook in this mode with the oven door closed.



SPEEDY BARBECUE mode

This mode can be used to cook the perfect barbecue in your oven. It quickly produces flawless results when grilling meat, fish and vegetables, without creating smoke. The temperature is set by default to 280°C; cooking durations, which may be set as desired, are recommended for various dishes and are listed in the cooking advice table (*see Cooking advice table*).



FREASY COOK mode

Preheating is not necessary for this cooking mode. This mode is particularly suitable for cooking pre-packed food quickly (frozen or pre-cooked). The best results are achieved using one cooking rack only.







PIZZA mode

This combination heats the oven rapidly by producing a considerable amount of heat, particularly from the element at the bottom. If you use more than one rack at a time, switch the position of the dishes halfway through the cooking process.

KEEP WARM mode

This type of cooking mode can be used to keep hot, previously-cooked foods warm, or to reheat dishes. The temperature is set by default to 65°C and cannot be adjusted.



TABLE OF CHARACTERISTICS

Dimensions	width 43.5 cm height 32 cm depth 40 cm
Volume	56 l
Electrical connections	voltage: 230-240 V~ 50/60 Hz maximum power absorbed 2800-3000 W
ENERGY LABEL	Directive 2002/40/EC on the label of electric ovens. Standard EN 50304 Energy consumption for Natural convection – heating mode:  Traditional mode Declared energy consumption for Forced convection Class – heating mode:  Gratin.
 	This appliance conforms to the following European Economic Community directives: 2006/95/EEC dated 12.12.06 (Low Voltage) and subsequent amendments – 2004/108/EEC dated 15/12/04 (Electromagnetic Compatibility) and subsequent amendments - 93/68/EEC dated 22/07/93 and subsequent amendments. 2002/96/EEC and subsequent amendments. 1275/2008 Stand-by/off mode

Programming cooking





! A cooking mode must be selected before programming can take place.



Programming the cooking duration

1. Press the  button several times until the  icon and the three digits on the display begin to flash.
2. Turn the TIMER KNOB towards "+" and "-" to adjust the duration as desired.
3. Press the  button again to confirm.
4. When the set time has elapsed, the text END appears on the DISPLAY, the oven will stop cooking and a buzzer sounds.
 - For example: it is 9:00 a.m. and a time of 1 hour and 15 minutes is programmed. The programme will stop automatically at 10:15 a.m.

Setting the end time for a cooking mode

! A cooking duration must be set before the cooking end time can be scheduled.

1. Follow steps 1 to 3 to set the duration as detailed above.
2. Next, press the  button until the  icon and the two digits on the DISPLAY begin to flash.
3. Turn the TIMER KNOB towards "+" and "-" to adjust the hour value.
4. Press the  button again so that the other two numerical digits on the DISPLAY begin to flash.
5. Turn the TIMER KNOB towards "+" and "-" to adjust the minute value.
6. Press the  button again to confirm.
7. When the set time has elapsed, the text END appears on the DISPLAY; the oven will stop cooking and a buzzer sounds.

Programming has been set when the  and  buttons are illuminated. The DISPLAY shows the cooking end time and the cooking duration alternately.

To cancel programming, turn the SELECTOR knob to the "0" position.

Practical cooking advice

! Do not place racks in position 1 and 5 during fan-assisted cooking. This is because excessive direct heat can burn temperature sensitive foods.

! In the GRILL and GRATIN cooking modes, particularly when using the rotisserie spit, place the dripping pan in position 1 to collect cooking residues (fat and/or grease).

MULTILEVEL

- Use positions 2 and 4, placing the food which requires more heat on 2.
- Place the dripping pan on the bottom and the rack on top.

GRILL

- Place the rack in position 3 or 4. Position the food in the centre of the rack.
- We recommend that the power level is set to maximum. The top heating element is regulated by a thermostat and may not always operate constantly.

SPEEDY BARBECUE

- Position the rack on level 4 and the dripping pan on level 1.
- This is the accessory configuration you should use if you wish to achieve perfect barbecued results for every type of dish, without creating smoke or making the appliance dirty. When you have finished cooking, all excess fat will have collected in the dripping pan with the water and the accessories will be very easy to clean.

PIZZA

- Use a light aluminium pizza pan. Place it on the rack provided.
For a crispy crust, do not use the dripping pan as this extends the total cooking duration and prevents the crust from forming.
- If the pizza has a lot of toppings, we recommend adding the mozzarella cheese on top of the pizza halfway through the cooking process.

Cooking advice table

Cooking modes	Foods	Weight (in kg)	Rack position		Preheating	Recommended Temperature (°C)	Cooking duration (minutes)
			Standard guide rails	Sliding guide rails			
Convection	Duck	1,5	2	1	Yes	200-210	70-80
	Chicken	1,5	2	1	Yes	200-210	60-70
	Roast veal or beef	1	2	1	Yes	200	70-75
	Roast pork	1	2	1	Yes	200-210	70-80
	Biscuits (shortcrust pastry)	-	2	1	Yes	180	15-20
	Pies / Tarts	1	2	1	Yes	180	30-35
Multilevel	Pizza on 2 racks		2 and 4	1 and 3	Yes	220-230	20-25
	Pies on two racks/cakes on 2 racks		2 and 4	1 and 3	Yes	180	30-35
	Sponge cake on 2 racks (on the dripping pan)		2 and 4	1 and 3	Yes	170	20-25
	Roast chicken + potatoes	1+1	1 and 2/3	1 and 3	Yes	200-210	65-75
	Lamb	1	2	1	Yes	190-200	45-50
	Mackerel	1	1 or 2	1	Yes	180	30-35
	Lasagne	1	2	1	Yes	190-200	35-40
	Cream puffs on 2 racks		2 and 4	1 and 3	Yes	190	20-25
	Biscuits on 2 racks		2 and 4	1 and 3	Yes	190	10-20
	Cheese puffs on 2 racks		2 and 4	1 and 3	Yes	210	20-25
Savoury pies		1 and 3	1 and 3	Yes	200	20-30	
Grill	Mackerel	1	4	3	No	100%	15-20
	Sole and cuttlefish	0,7	4	3	No	100%	10-15
	Squid and prawn kebabs	0,7	4	3	No	100%	8-10
	Cod fillet	0,7	4	3	No	100%	10-15
	Grilled vegetables	0,5	3 or 4	2 or 3	No	100%	15-20
	Veal steak	0,8	4	3	No	100%	15-20
	Sausages	0,7	4	3	No	100%	15-20
	Hamburgers	4 or 5	4	3	No	100%	10-12
	Toasted sandwiches (or toast)	4 or 6	4	3	No	100%	3-5
	Spit-roast chicken using rotisserie spit (where present)	1	-	-	No	100%	70-80
	Spit-roast lamb using rotisserie spit (where present)	1	-	-	No	100%	70-80
	Gratin	Grilled chicken	1,5	2	2	No	210
Cuttlefish		1	2	2	No	200	30-35
Spit-roast chicken using rotisserie spit (where present)		1,5	-	-	No	210	70-80
Spit-roast duck using rotisserie spit (where present)		1	2	2	No	210	60-70
Roast veal or beef		1	2	2	No	210	70-80
Roast pork		1	2	2	No	210	40-45
Lamb							
Speedy Barbecue*	Mackerel	1	4	3	No	270	11-16
	Sole and cuttlefish	0,7	4	3	No	270	6-11
	Squid and prawn kebabs	0,7	4	3	No	270	4-6
	Cod fillet	0,7	4	3	No	270	6-11
	Grilled vegetables	0,5	3 or 4	2 or 3	No	270	11-16
	Veal steak	0,8	4	3	No	270	11-16
	Sausages	0,7	4	3	No	270	11-16
	Hamburgers	4 or 5	4	3	No	270	6-8
Fready cook	Frozen food	0.3	2	1	-	250	12
	Pizza	0.4	2	1	-	200	20
	Courgette and prawn pie	0.5	2	1	-	220	30-35
	Country style spinach pie	0.3	2	1	-	200	25
	Turnovers	0.5	2	1	-	200	35
	Lasagne	0.4	2	1	-	180	25-30
	Golden Rolls	0.4	2	1	-	220	15-20
	Chicken bites						
	Pre-cooked food						
	Golden chicken wings	0.4	2	1	-	200	20-25
Fresh Food	Biscuits (shortcrust pastry)	0.3	2	1	-	200	15-18
	Sponge cake made with yoghurt	0.6	2	1	-	180	45
	Cheese puffs	0.2	2	1	-	210	10-12
Pizza	Pizza	0,5	2	1	Yes	220	15-20
	Focaccia bread	0,5	2	1	Yes	200	20-25
Keep warm	Defrosting		2 or 3	2	No	65	-
	Proving		2 or 3	2	No	65	60-90
	Dish reheating		2 or 3	2	No	65	-
	Pasteurisation		2 or 3	2	No	65	-

! The cooking times listed above are intended as guidelines only and may be modified according to personal tastes. Oven preheating times are set as standard and may not be modified manually.

* Position the dripping pan, with the water, on shelf level 1.

! This appliance has been designed and manufactured in compliance with international safety standards. The following warnings are provided for safety reasons and must be read carefully.

General safety

- The appliance was designed for domestic use inside the home and is not intended for commercial or industrial use.
- The appliance must not be installed outdoors, even in covered areas. It is extremely dangerous to leave the appliance exposed to rain and storms.
- When moving or positioning the appliance, always use the handles provided on the sides of the oven.
- Do not touch the appliance with bare feet or with wet or damp hands and feet.
- The appliance must be used by adults only for the preparation of food, in accordance with the instructions provided in this booklet.
- **Do not touch the heating elements or certain parts of the oven door when the appliance is in use; these parts become extremely hot. Keep children well away from the appliance.**
- Make sure that the power supply cables of other electrical appliances do not come into contact with the hot parts of the oven.
- The openings used for ventilation and the dispersion of heat must never be covered.
- Always grip the oven door handle in the centre: the ends may be hot.
- Always use oven gloves when placing cookware in the oven or when removing it.
- Do not use aluminium foil to line the bottom of the oven.
- Do not place flammable materials in the oven: if the appliance is switched on accidentally, the materials could catch fire.
- Always make sure the knobs are in the “●”/“○” position when the appliance is not in use.
- When unplugging the appliance, always pull the plug from the mains socket; do not pull on the cable.
- Never perform any cleaning or maintenance work without having disconnected the appliance from the electricity mains.
- If the appliance breaks down, under no circumstances should you attempt to perform the repairs yourself. Repairs carried out by inexperienced persons may cause injury or further malfunctioning of the appliance. Contact a Service Centre (*see Assistance*).
- Do not rest heavy objects on the open oven door.

- The appliance should not be operated by people (including children) with reduced physical, sensory or mental capacities, by inexperienced individuals or by anyone who is not familiar with the product. These individuals should, at the very least, be supervised by someone who assumes responsibility for their safety or receive preliminary instructions relating to the operation of the appliance.
- Do not let children play with the appliance.

Disposal

- When disposing of packaging material: observe local legislation so that the packaging may be reused.
- The European Directive 2002/96/EC relating to Waste Electrical and Electronic Equipment (WEEE) states that household appliances should not be disposed of using the normal solid urban waste cycle. Exhausted appliances should be collected separately in order to optimise the cost of re-using and recycling the materials inside the machine, while preventing potential damage to the atmosphere and to public health. The crossed-out dustbin is marked on all products to remind the owner of their obligations regarding separated waste collection. For further information relating to the correct disposal of exhausted household appliances, owners may contact the public service provided or their local dealer.

Respecting and conserving the environment

- You can help to reduce the peak load of the electricity supply network companies by using the oven in the hours between late afternoon and the early hours of the morning. The cooking mode programming options, the “delayed cooking” mode (*see Cooking modes*) in particular, enable the user to organise their time efficiently.
- Check the door seals regularly and wipe them clean to ensure they are free of debris so that they adhere properly to the door, thus avoiding heat dispersion.

! This product complies with the requirements of the latest European Directive on the limitation of power consumption of the standby mode.

If no operations are carried out for a period of 2 minutes, the appliance automatically switches to the standby mode.

The standby mode is visualised by the high luminosity “Watch Icon”.

As soon as interaction with the machine resumes, the system's operating mode is restored.

Care and maintenance

GB

Switching the appliance off

Disconnect your appliance from the electricity supply before carrying out any work on it.

Cleaning the appliance

- The stainless steel or enamel-coated external parts and the rubber seals may be cleaned using a sponge that has been soaked in lukewarm water and neutral soap. Use specialised products for the removal of stubborn stains. After cleaning, rinse and dry thoroughly. Do not use abrasive powders or corrosive substances.
- The inside of the oven should ideally be cleaned after each use, while it is still lukewarm. Use hot water and detergent, then rinse well and dry with a soft cloth. Do not use abrasive products.
- The accessories can be washed like everyday crockery, and are even dishwasher safe.

! Never use steam cleaners or pressure cleaners on the appliance.

Cleaning the oven door

Clean the glass part of the oven door using a sponge and a non-abrasive cleaning product, then dry thoroughly with a soft cloth. Do not use rough abrasive material or sharp metal scrapers as these could scratch the surface and cause the glass to crack.

For more thorough cleaning purposes, the oven door may be removed:



1. Open the oven door fully (*see diagram*).

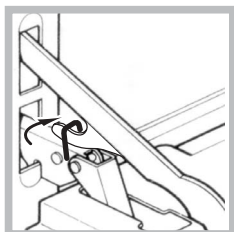

2. Lift up and turn the small levers located on the two hinges (*see diagram*).

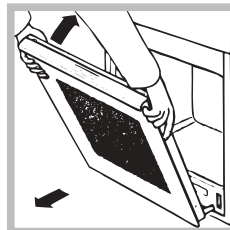

3. Grip the door on the two outer sides and close it approximately half way. Pull the door towards you, lifting it out of its slot (*see diagram*).

To replace the door, reverse this sequence.

Inspecting the seals

Check the door seals around the oven regularly. If the seals are damaged, please contact your nearest After-sales Service Centre (*see Assistance*). We recommend that the oven is not used until the seals have been replaced.

Replacing the light bulb

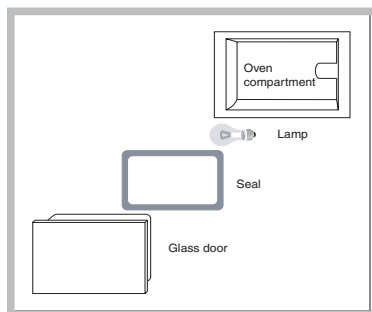

To replace the oven light bulb:

1. Remove the glass cover using a screwdriver.
2. Unscrew the light bulb and replace it with a similar one: Wattage 15 W, cap E 14.

Replace the glass cover, making sure the seal is positioned correctly (*see diagram*).

AUTOMATIC CLEANING mode

During the AUTOMATIC CLEANING cycle, the internal temperature of the oven reaches 500°C. The pyrolytic cycle is activated, burning away food and grime residues. Dirt is literally incinerated. Keep children away from the appliance during the automatic cleaning cycle as surfaces may become very hot. Particles may ignite inside the oven as a result of the combustion process. There is no cause for concern: this process is both normal and hazard-free.

Before activating the AUTOMATIC CLEANING cycle:

- Remove large or coarse food residues from the inside of the oven using a damp sponge. Do not use detergents.
- Remove all accessories.
- Do not place tea towels or pot holders over the oven handle.
- Turn the SELECTOR knob to the "0" position.

! If the oven is too hot, the pyrolytic cycle may not start. Wait for the oven to cool down.



! The programme may only be started once the oven door has been closed.

To activate the AUTOMATIC CLEANING cycle press and hold the  button for approximately 4 seconds. The TIMER KNOB may be used to select the desired cleaning level; there are three default time settings which cannot be modified.





1. Economy (ECO): turn the knob towards "-". Duration 1 hour.
2. Normal (NOR): initial level. Duration 1 hour and 30 minutes.
3. Intensive (INT): turn the knob towards "+". Duration 2 hours.
4. Press the  button to confirm.



An end time for the AUTOMATIC CLEANING cycle (as for a normal cooking cycle) may be programmed (see *Programming the automatic cleaning end time*).

Safety devices

- The  icon on the display, when lit, indicates that the oven door was automatically locked as soon as the temperature reached a high value.
- The **STOP** icon indicates that the cleaning cycle may be cancelled at any time by pressing the  button.
- If a malfunction occurs, the heating elements will be switched off.
- Once the oven door has been locked, you cannot change the duration and cycle end time settings.

Programming the automatic cleaning end time

1. Press the  button until the  icon and the two digits on the DISPLAY begin to flash.
 2. Turn the TIMER KNOB towards "+" and "-" to adjust the hour value.
 3. Press the  button again so that the other two numerical digits on the DISPLAY begin to flash.
 4. Turn the TIMER KNOB towards "+" and "-" to adjust the minute value.
 5. Press the  button again to confirm.
 6. When the set time has elapsed, the text END appears on the display and a buzzer sounds.
- For example: it is 9:00 a.m. and the AUTOMATIC CLEANING Economy level has been selected, with the default duration of 1 hour. 12:30 is scheduled as the end time. The programme will start automatically at 11:30 a.m.

Programming has been set when the  and  buttons are illuminated. The DISPLAY shows the AUTOMATIC CLEANING end time and the duration alternately.

Once the automatic cleaning cycle is over

You will have to wait until the temperature inside the oven has cooled down sufficiently before you can open the oven door. You will notice some white dust deposits on the bottom and the sides of your oven; remove these deposits with a damp sponge once the oven has cooled down completely. Alternatively, you can make use of the already heated oven, in which case it is not necessary to remove the deposits, they are completely harmless and will not affect your food in any way.

Assistance

GB

Warning:

The appliance is fitted with an automatic diagnostic system which detects any malfunctions. Malfunctions are indicated on the display, by messages of the following type: "F" followed by numbers.

Call for technical assistance if a malfunction occurs.

! Never use the services of an unauthorised technician.

Please have the following information to hand:

- The type of problem encountered.
- The appliance model (Mod.).
- The serial number (S/N).

The latter two pieces of information can be found on the data plate located on the appliance.



Guarantee

12 months Parts and Labour Guarantee

Your appliance has the benefit of our manufacturer's guarantee, which covers the cost of breakdown repairs for twelve months from the date of purchase.

This gives you the reassurance that if, within that time, your appliance is proven to be defective because of either workmanship or materials, we will, at our discretion, either repair or replace the appliance at no cost to you.

This guarantee is subject to the following conditions:

- The appliance has been installed and operated correctly and in accordance with our operating and maintenance instructions.
- The appliance is used only on the electricity or gas supply printed on the rating plate.
- The appliance has been used for normal domestic purposes only.
- The appliance has not been altered, serviced, maintained, dismantled, or otherwise interfered with by any person not authorised by us.
- Any repair work must be undertaken by us or our appointed agent.
- Any parts removed during repair work or any appliance that is replaced become our property.
- The appliance is used in the United Kingdom or Republic of Ireland.

The guarantee does not cover:

- Damage resulting from transportation, improper use, neglect or interference or as a result of improper installation.
- Replacement of any consumable item or accessory. These included but not limited to: plugs, cables, batteries, light bulbs, fluorescent tubes and starters, covers and filters.
- Replacement of any removable parts made of glass or plastic.

THIS GUARANTEE WILL NOT APPLY IF THE APPLIANCE HAS BEEN USED IN COMMERCIAL OR NON-DOMESTIC PREMISES.

5 Year Parts Guarantee

Indesit also offers you a free 5 year parts guarantee. This additional guarantee is conditional on you registering your appliance with us and the parts being fitted by one of our authorised engineers. There will be a charge for our engineer's time. To activate the extra parts warranty on your appliance, simply call our registration line on **08448 24 24 24 (Republic of Ireland 01 230 0800)**

Extended Guarantees

We offer a selection of protection plans that enable you to fully cover yourself against the expense of repair bills for the life of your policy. To find the ideal plan for you please call our advice line on **08448 226 226 (Republic of Ireland 01 230 0233)**.

Free Helpdesk Service

We have a dedicated team who can provide free advice and assistance with your appliance if you experience any technical difficulties within the first 90 days of ownership. Simply call our Indesit Service Hotline on **08448 224 224 (Republic of Ireland 0818 313 413)** for telephone assistance, or, where necessary, to arrange for an engineer to call.



After Sales Service

No one is better placed to care for your Indesit appliance during the course of its working life than us – the manufacturer.

Essential Contact Information

Indesit Service

We are the largest service team in the UK and Ireland offering you access to 400 skilled telephone advisors and 1000 fully qualified engineers on call to ensure you receive fast, reliable, local service.

UK: 08448 224 224
Republic of Ireland: 0818 313 413
www.indesitservice.co.uk

Please note: Our advisors will require the following information:

Model number:

Serial number:

Parts and Accessories

We supply a full range of genuine replacement parts as well as accessory products that protect and hygienically clean your appliance to keep it looking good and functioning efficiently throughout its life.

UK: 08448 225 225
Republic of Ireland: 0818 313 413
www.indesitservice.co.uk

Appliance Registration

We want to give you additional benefits of Indesit ownership. To activate your free 5 year parts guarantee you must register your appliance with us.

UK: 08448 24 24 24
Republic of Ireland: 01 230 0800
www.indesitservice.co.uk

Indesit Company UK Ltd. Morley Way, Peterborough, PE2 9JB
Indesit Company Unit 49 Airways Industrial Estate, Dublin 17

Recycling and Disposal Information

As part of Indesit's continued commitment to helping the environment, Indesit reserves the right to use quality, recycled components to keep down customer costs and minimise material wastage.

Please dispose of packaging and old appliances carefully. To minimise the risk of injury to children, remove the door, plug, and cut the mains cable off flush with the appliance. Dispose of these parts separately to ensure that the appliance can no longer be plugged into mains socket, and the door cannot be locked shut.

